

LAVABO INTEGRATO

DELTA 50.23

CURA E MANUTENZIONE:

Per una pulizia quotidiana, basta risciacquare il lavabo, dai residui di shampoo e sapone con acqua e lasciar asciugare naturalmente con un corretto ricircolo dell'aria.

Per una pulizia più accurata, usare solo panni morbidi e detersivi neutri non abrasivi. Non usare assolutamente tamponi con fili metallici, panni con fibre sintetiche, spugne abrasive e detersivi liquidi contenenti, abrasivi, acetone, acidi e altri solventi, in quanto potrebbero rovinare la superficie del lavabo.

ACCESSORI:

SCARICO LIBERO CON TAPPO IN SOLYGEL/SOLYSAND:

Piletta per scarico libero 1" 1/4 con tappo in Solygel/Solysand in tinta.
(da richiedere)

SCARICO CLICK CLACK CON TAPPO IN SOLYGEL/SOLYSAND:

Piletta per scarico click clack 1" 1/4 con tappo in Solygel/ Solysand in tinta. (da richiedere)

TAPPO IN SOLYGEL/SOLYSAND:

Tappo con copertura in Solygel/ Solysand in tinta.

KIT TROPPOPIENO:

Kit per predisposizione troppopieno del lavabo
(da richiedere)



CARATTERISTICHE TECNICHE:

UNI EN 14688



Resistente alle variazioni temperature

UNI EN 14688



Resistenza agenti chimici

UNI EN 14688



Resistenza all'abrasione

UNI EN 14688



Resistenza ai graffi

CUSTOMIZZAZIONE:

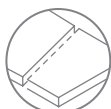

Taglio

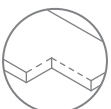

Scanso



Raggiatura



Incollaggio



Alzatina



Scatolatura



Foro troppopieno



Foro miscelatore

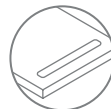

Foro porta salviette



Doppia vasca



Bisellatura

MATERIALE:



SOLYGEL® 11
Bianco Opaco



SOLYGEL® 01
Bianco Lucido



SOLYGEL®
COSTUM Opaco



SOLYSAND® SS11
Bianco Opaco

DIMENSIONI:

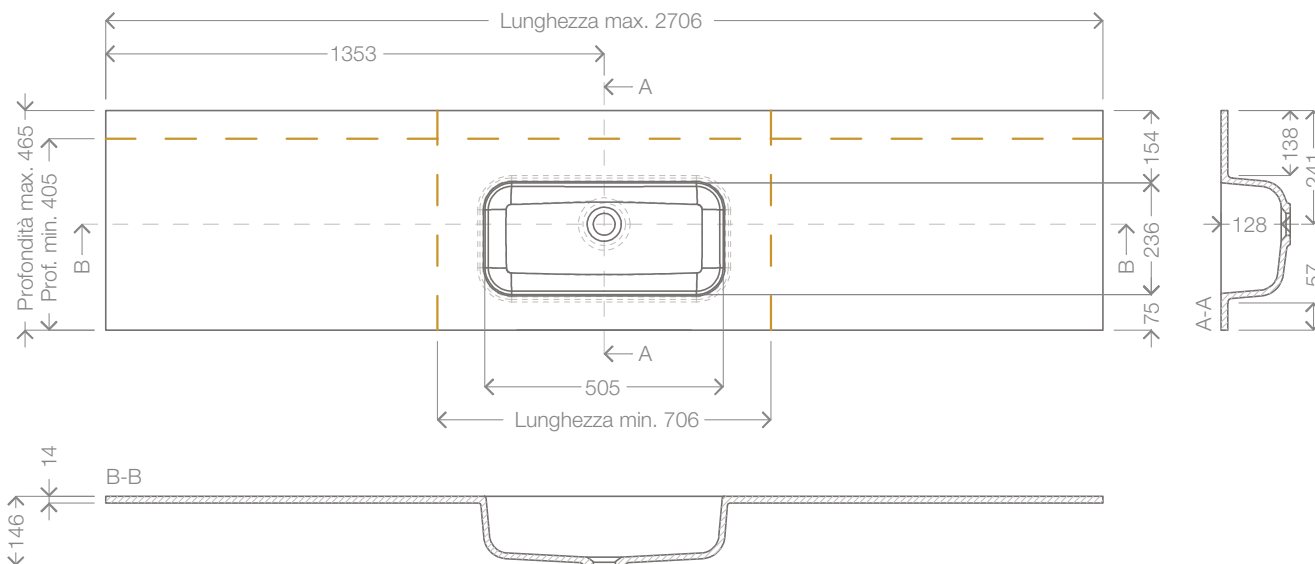

LAVABO INTEGRATO

DELTA 57.30

CURA E MANUTENZIONE:

Per una pulizia quotidiana, basta risciacquare il lavabo, dai residui di shampoo e sapone con acqua e lasciar asciugare naturalmente con un corretto ricircolo dell'aria.

Per una pulizia più accurata, usare solo panni morbidi e detersivi neutri non abrasivi. Non usare assolutamente tamponi con fili metallici, panni con fibre sintetiche, spugne abrasive e detersivi liquidi contenenti, abrasivi, acetone, acidi e altri solventi, in quanto potrebbero rovinare la superficie del lavabo.

ACCESSORI:

SCARICO LIBERO CON TAPPO IN SOLYGEL/SOLYSAND:

Piletta per scarico libero 1" 1/4 con tappo in Solygel/Solysand in tinta.
(da richiedere)

SCARICO CLICK CLACK CON TAPPO IN SOLYGEL/SOLYSAND:

Piletta per scarico click clack 1" 1/4 con tappo in Solygel/ Solysand in tinta. (da richiedere)

TAPPO IN SOLYGEL/SOLYSAND:

Tappo con copertura in Solygel/ Solysand in tinta.

KIT TROPPOPIENO:

Kit per predisposizione troppopieno del lavabo
(da richiedere)



CARATTERISTICHE TECNICHE:

UNI EN 14688



Resistente alle variazioni temperature

UNI EN 14688



Resistenza agenti chimici

UNI EN 14688



Resistenza all'abrasione

UNI EN 14688



Resistenza ai graffi

CUSTOMIZZAZIONE:



Taglio

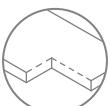

Scanso



Raggiatura



Incollaggio



Alzatina



Scatolatura



Foro troppopieno



Foro miscelatore



Foro porta salviette



Doppia vasca

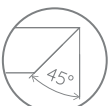

Bisellatura

MATERIALE:



SOLYGEL® 11
Bianco Opaco



SOLYGEL® 01
Bianco Lucido



SOLYGEL®
COSTUM Opaco



SOLYSAND® SS11
Bianco Opaco

DIMENSIONI:

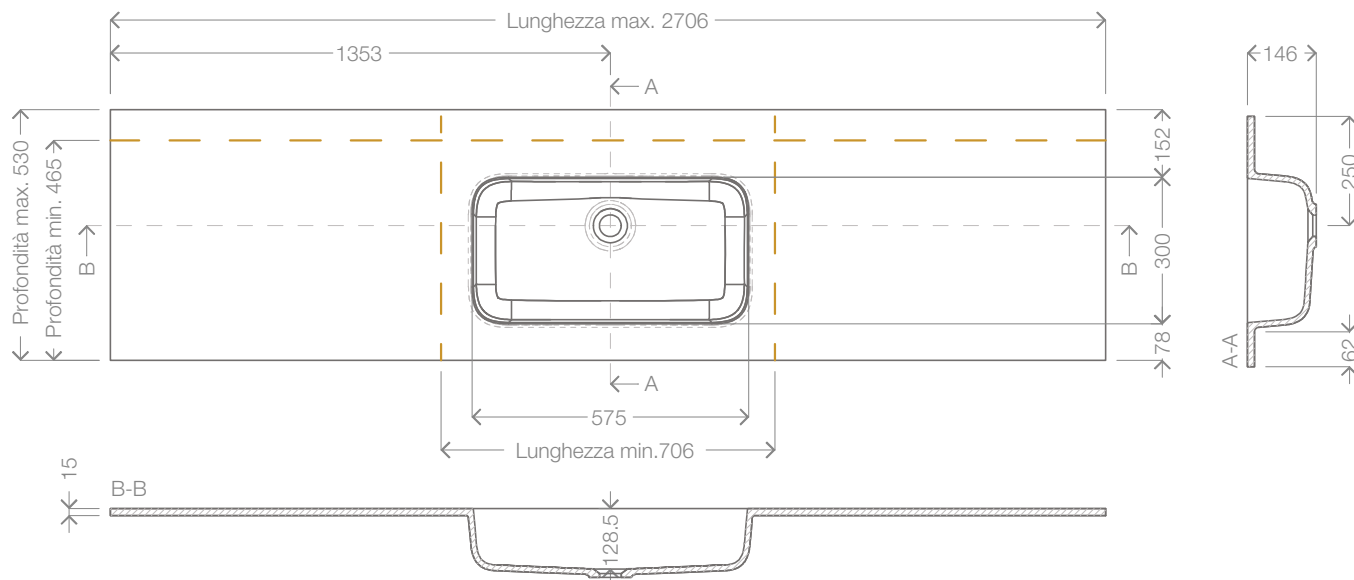

LAVABO INTEGRATO

DELTA 58.28

CURA E MANUTENZIONE:

Per una pulizia quotidiana, basta risciacquare il lavabo, dai residui di shampoo e sapone con acqua e lasciar asciugare naturalmente con un corretto ricircolo dell'aria.

Per una pulizia più accurata, usare solo panni morbidi e detersivi neutri non abrasivi. Non usare assolutamente tamponi con fili metallici, panni con fibre sintetiche, spugne abrasive e detersivi liquidi contenenti, abrasivi, acetone, acidi e altri solventi, in quanto potrebbero rovinare la superficie del lavabo.

ACCESSORI:

SCARICO LIBERO CON TAPPO IN SOLYGEL/SOLYSAND:

Piletta per scarico libero 1" 1/4 con tappo in Solygel/Solysand in tinta.
(da richiedere)

SCARICO CLICK CLACK CON TAPPO IN SOLYGEL/SOLYSAND:

Piletta per scarico click clack 1" 1/4 con tappo in Solygel/ Solysand in tinta. (da richiedere)

TAPPO IN SOLYGEL/SOLYSAND:

Tappo con copertura in Solygel/ Solysand in tinta.

KIT TROPPOPIENO:

Kit per predisposizione troppopieno del lavabo
(da richiedere)



CARATTERISTICHE TECNICHE:

UNI EN 14688



Resistente alle variazioni temperature

UNI EN 14688



Resistenza agenti chimici

UNI EN 14688



Resistenza all'abrasione

UNI EN 14688



Resistenza ai graffi

CUSTOMIZZAZIONE:



Taglio

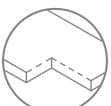

Scanso



Raggiatura

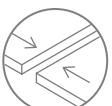

Incollaggio



Alzatina



Scatolatura

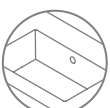

Foro troppopieno

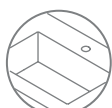

Foro miscelatore

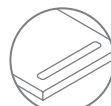

Foro porta salviette



Doppia vasca

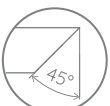

Bisellatura

MATERIALE:



SOLYGEL® 11
Bianco Opaco



SOLYGEL® 01
Bianco Lucido



SOLYGEL®
COSTUM Opaco



SOLYSAND® SS11
Bianco Opaco

DIMENSIONI:

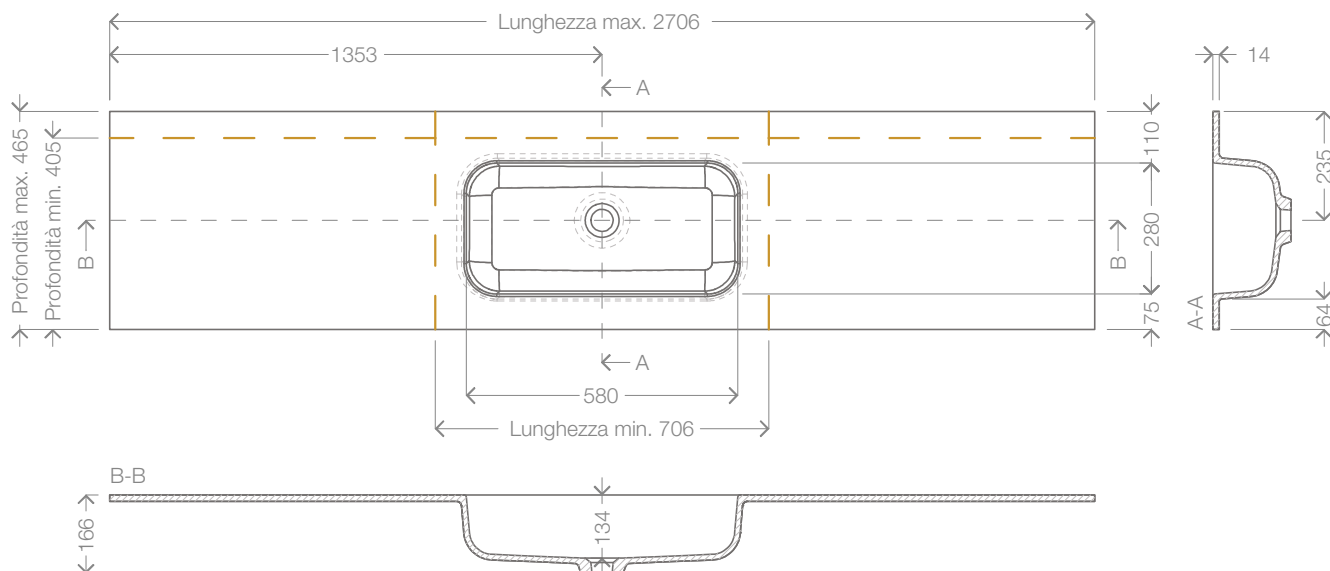

LAVABO INTEGRATO

DELTA 48.30

CURA E MANUTENZIONE:

Per una pulizia quotidiana, basta risciacquare il lavabo, dai residui di shampoo e sapone con acqua e lasciar asciugare naturalmente con un corretto ricircolo dell'aria.

Per una pulizia più accurata, usare solo panni morbidi e detersivi neutri non abrasivi. Non usare assolutamente tamponi con fili metallici, panni con fibre sintetiche, spugne abrasive e detersivi liquidi contenenti, abrasivi, acetone, acidi e altri solventi, in quanto potrebbero rovinare la superficie del lavabo.

ACCESSORI:

SCARICO LIBERO CON TAPPO IN SOLYGEL/SOLYSAND:

Piletta per scarico libero 1" 1/4 con tappo in Solygel/Solysand in tinta.
(da richiedere)



SCARICO CLICK CLACK CON TAPPO IN SOLYGEL/SOLYSAND:

Piletta per scarico click clack 1" 1/4 con tappo in Solygel/ Solysand in tinta. (da richiedere)



TAPPO IN SOLYGEL/SOLYSAND:

Tappo con copertura in Solygel/ Solysand in tinta.



KIT TROPPOPIENO:

Kit per predisposizione troppopieno del lavabo (da richiedere)

CARATTERISTICHE TECNICHE:

UNI EN 14688



Resistente alle variazioni temperature

UNI EN 14688



Resistenza agenti chimici

UNI EN 14688



Resistenza all'abrasione

UNI EN 14688



Resistenza ai graffi

CUSTOMIZZAZIONE:

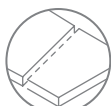

Taglio

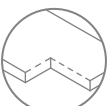

Scanso



Raggiatura



Incollaggio



Alzatina



Scatolatura



Foro troppopieno



Foro miscelatore



Foro porta salviette



Doppia vasca



Bisellatura

MATERIALE:



SOLYGEL® 11
Bianco Opaco



SOLYGEL® 01
Bianco Lucido



SOLYGEL®
COSTUM Opaco



SOLYSAND® SS11
Bianco Opaco

DIMENSIONI:

